

CODE 41 - HEAT SHRINK BOOT BACKSHELL

202M216-19C

SERIES _____
 ORDER NUMBER (TABLE 1) _____
 MATERIAL _____
 REFER TO CH00-0250-004
 FINISH _____
 REFER TO CH00-0250-004
 MODIFICATION CODE _____
 REFER TO CH00-0250-004 (2)

NOTES:



1. THIS PRODUCT IS DESIGNED TO TERMINATE A HEAT SHRINKABLE LIPPED BOOT TO A CONNECTOR.

(2) FOR ADDITIONAL DIMENSIONS, ORDERING INFORMATION AND MODIFICATIONS, SEE CH00-0250-004.

3. ADAPTOR TO BE PERMANENTLY MARKED/BAGGED AND LABELLED WITH CODE IDENTIFICATION NUMBER AND PART NUMBER. (e.g. 06090-202M216-19B).

(4) BACKSHELL MATES TO MIL-C-38999 SERIES I & II, CLASS E & T, MS27466, MS27467, MS27468, MS27472, MS27473, MS27474, MS27479, MS27480, MS27481, MS27484, MS27497, MS27653, MS27656 CONNECTORS.

If this document is printed it becomes uncontrolled. Check for the latest revision

DRAWN	K.WINCZURA	DATE	19/02/2015	 3RD ANGLE PROJECTION NOT TO SCALE	TITLE:	HEAT SHRINK BOOT BACKSHELL	 Polamco 			
CHECKED		DATE	19/02/2015							
APPROVED	K.SHEPPARD	DATE	03/03/2015		UNLESS OTHERWISE SPECIFIED ALL DIMENSIONS IN MILLIMETRES GENERAL TOL LINEAR +/-0.25MM ANGULAR +/- 1°	ASSY USED ON:		MIL-DTL-38999 SERIES I & II (CODE 41)		
APPROVED	H.SMITH	DATE	01/09/2015							
REVISIONS										
LTR	DESCRIPTION	DATE	APPROVED							
N	REVISED PER ECN AD93016									
P	REVISED PER ECO-15-011999	01/09/2015	H.SMITH							
TE CAGE CODE: 06090 POLAMCO/TE CAGE CODE: U5792					TE CONNECTIVITY - POLAMCO LTD RESERVES THE RIGHT TO AMEND THIS DRAWING AND THE INFORMATION SET FORTH HEREON AT ANY TIME. USERS SHOULD INDEPENDENTLY EVALUATE THE SUITABILITY OF THE PRODUCT FOR THEIR APPLICATION.			DRAWING NO: 202M2XX	DRAWING REV: P	SHT 1

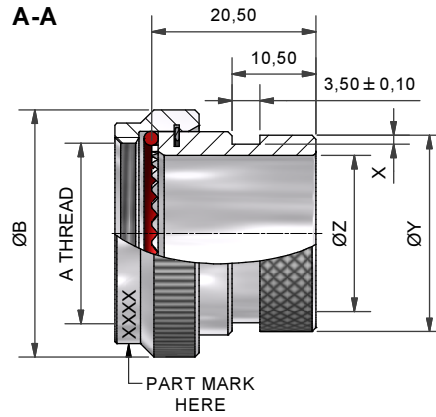





TABLE 1

ORDER NUMBER	SHELL SIZE SER 1 / SER 2	A THREAD	ØB MAX	X +0,20/-0,00	ØZ MIN	ØY +0,00/-0,50
08	09 / 08	7/16-28UNEF	18,3	1,12	6,60	13,50
10	11 / 10	9/16-24UNEF	21,5	1,12	10,00	15,40
12	13 / 12	11/16-24UNEF	24,5	1,12	12,90	19,70
14	15 / 14	13/16-20UNEF	27,8	1,12	16,10	21,30
16	17 / 16	15/16-20UNEF	30,8	1,12	19,30	24,50
18	19 / 18	1 1/16-18UNEF	34,1	1,12	21,70	26,50
20	21 / 20	1 3/16-18UNEF	37,3	1,75	24,80	31,00
22	23 / 22	1 5/16-18UNEF	40,5	1,75	28,20	34,40
24	25 / 24	1 7/16-18UNEF	43,7	1,75	31,30	36,60

DRAINHOLE OPTION



If this document is printed it becomes uncontrolled. Check for the latest revision

DRAWN	K.WINCZURA	DATE	19/02/2015	 3RD ANGLE PROJECTION NOT TO SCALE	TITLE: HEAT SHRINK BOOT BACKSHELL	 Polamco 		
CHECKED		19/02/2015						
APPROVED	K.SHEPPARD	03/03/2015	UNLESS OTHERWISE SPECIFIED ALL DIMENSIONS IN MILLIMETRES GENERAL TOL LINEAR +/-0,25MM ANGULAR +/- 1°					
APPROVED	H.SMITH	01/09/2015						
REVISIONS					ASSY USED ON: MIL-DTL-38999 SERIES I & II (CODE 41)	TE CONNECTIVITY - POLAMCO LTD RESERVES THE RIGHT TO AMEND THIS DRAWING AND THE INFORMATION SET FORTH HEREON AT ANY TIME. USERS SHOULD INDEPENDENTLY EVALUATE THE SUITABILITY OF THE PRODUCT FOR THEIR APPLICATION.		
LTR	DESCRIPTION	DATE	APPROVED	DRAWING NO:			DRAWING REV:	SHT
N	REVISED PER ECN AD93016			202M2XX			P	2
P	REVISED PER ECO-15-011999	01/09/2015	H.SMITH					
TE CAGE CODE: 06090 POLAMCO/TE CAGE CODE: U5792								